



DIAMANTE 630



Pastry & Ice Cream

Restaurants

Wine

Beverage Ice & Storage

Catering Equipment

Minimarket



Ultimo ripiano in basso a specchio
Bottom mirror shelf
Dernière étagère en bas au miroir
Letzte Auflage unten Spiegel
Estante inferior de espejo

TNV-PG	Lt. 570	Watt 538	N° 5 Ø mm. 560	°C +4/+10		230V/1/50Hz		R 404a	Kg. 184
TBV-PG	Lt. 570	Watt 538	N° 5 Ø mm. 560	°C +5/-17		230V/1/50Hz		R 404a	

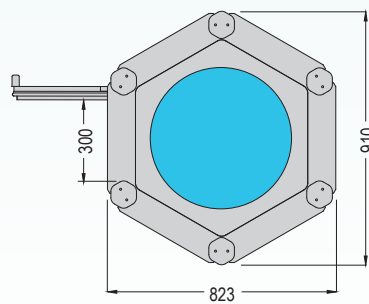
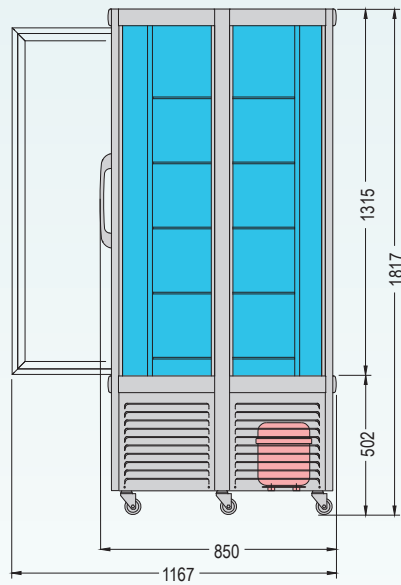
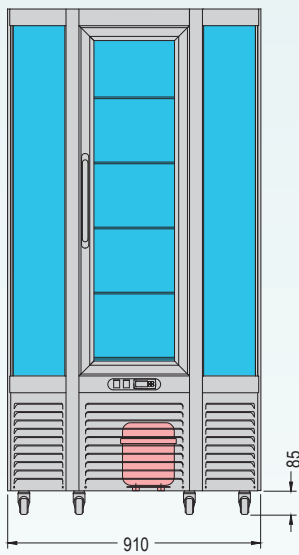
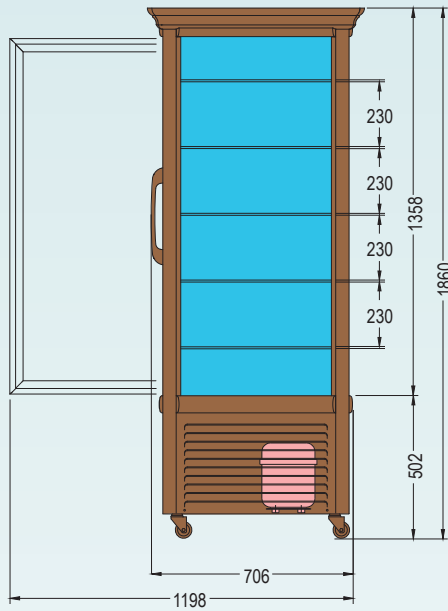
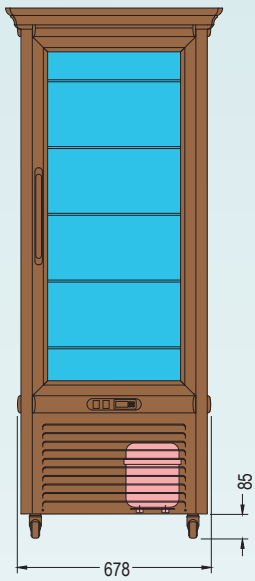
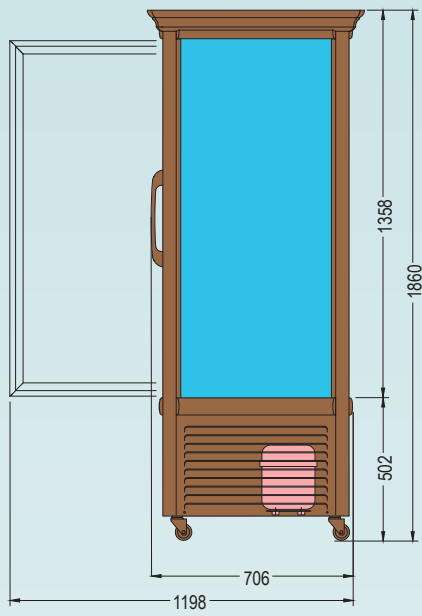
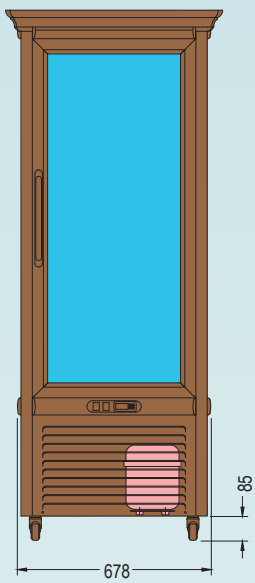

Dorica 400
TNV/PF

Dorica 400
TNV/PG

Dorica 400
TPV/PF Pral

Dorica 400
TPV/PG Pral

Dorica 400
TBV/PF

Dorica 400
TBS/PF

Diamante 630
TNV/PG

Diamante 630
TBV/PG

Pastry & Ice Cream

Restaurants

Wine

Beverage Ice & Storage

Catering Equipment

Minimarket



Legenda Symbols



Modello
Model
Modèle
Modell
Modelo



Umidità
Humidity
Hygrométrie
Luftfeuchtigkeit
Humedad



Potenza compressore
Compressor power
Puissance compresseur
Leistung des Kompressors
Potencia compresor



Capacità netta
Net capacity
Capacité nette
Netto Kapazität
Capacidad neta



Ripiani a griglia
Grating shelves
Étagères à grille
Gitter-Fächer
Repisas enrejadas



Ripiani rotanti in vetro
Rotating glass shelves
Étagères tournantes en verre
Drehbare Glasfächer
Repisas giratorias de vidrio



Ripiani in cristallo
Crystal plates
Tablettes en cristal
Glasteller
Estantes de cristal



Ripiani esagonali
Hexagonal shelves
Étagères hexagonals
Hexagonale Auflagen
Estantes hexagonales



Voltaggio di serie
Standard voltage
Voltage standard
Serienmäßige Spannung
Voltaje en serie



Temperatura
Temperature
Température
Temperatur
Temperatura



Sbrinamento automatico
Automatic defrosting
Dégivrage automatique
Automatisches Abtauen
Descongelación automática



Sbrinamento manuale
Manual defrosting
Dégivrage manuel
Manuelles Abtauen
Descongelación manual



Refrigerazione statica
Static refrigeration
Réfrigération statique
Statische Kühlung
Refrigeración estática



Refrigerazione
Réfrigération
Kühlung
Refrigeración



Refrigerazione agitata
Fan assisted refrigeration
Réfrigération troublee
Geschüttelte Kühlung
Refrigeración estática con seudo-ventilador



Refrigerazione ventilata
Ventilated refrigeration
Réfrigération ventilée
Belüftete Kühlung
Refrigeración ventilada



Potenze resistenze Bain-Marie
Bain-Marie heating elements power
Puissance des résistances Bain-Marie
Leistung der wasserbadheizkörper
Potencia resistencias Baño Maria



Gas refrigerante
Cooling gas
Gaz réfrigérant
Kühlgas
Gas refrigerante



Bacinelle
Trays
Cuvettes
Schalen
Bandejas



Peso netto
Net weight
Poids net
Nettogewicht
Peso neto