

CB 316 / CB 416 / CB 425



CB Series



CB 316/416



CB 425



**Produttori automatici di ghiaccio in cubetti
- sistema a spruzzo.**

Cubetti di qualità: compatti, freddi e cristallini.
Il ghiaccio prodotto cade nel contenitore di raccolta pronto
a soddisfare le esigenze di ghiaccio nelle ore di maggiore
richiesta.

Automatic ice cube maker - spray system.

Quality cubes: compact, cold and crystalline.
The ice produced drops into the collection bin and is ready
to meet the ice requirements even at peak demand times.

Machines à glaçons - système à projection d'eau.



Cubes de qualité: compacts et cristallins.
Les glaçons produits tombent dans la réserve prêts à
satisfaire les exigences aux heures de pointe.





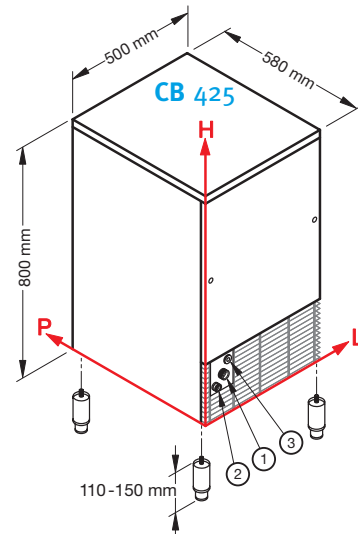
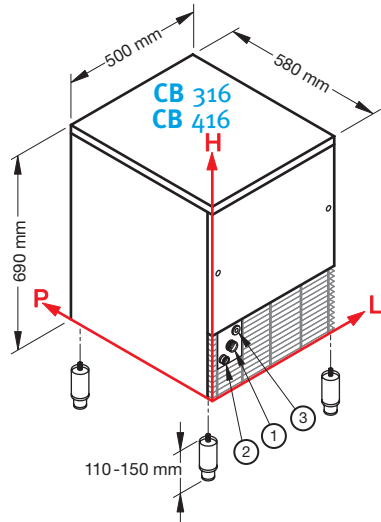





CB Series

CB 316-416 / CB 425



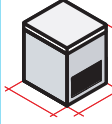
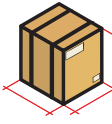



	1 			2 			3 		
	L	H	Ø	L	H	Ø	L	H	Ø
CB 316	111	196	3/4"	49	151	24mm	156	232	-
CB 416	111	196	3/4"	49	151	24mm	156	232	-
CB 425	111	196	3/4"	49	151	24mm	156	232	-



	Produzione in 24 h, sino a Production in 24 h, till Production en 24 h, jusqu'à	Capacità contenitore Storage capacity Réserve	Raffreddamento Cooling system Condenseur	Tipo di cubetto Kind of cube Type de glaçon	Refrigerante Refrigerant Fluide réfrigérant	Voltaggio standard Standard voltage Tension standard	Potenza assorbita Input power Puissance absorbée	Consumo acqua (l/kg) Water consumption (l/kg) Consommation d'eau (l/kg)	Dimensioni (LxPxH) Sizes (MxDxH) Dimension (LxPxH)	Dimensioni con imballo (LxPxH) Sizes with packing (MxDxH) Dimension avec emballage (LxPxH)	Peso netto/lordo Weight net/gross Poids net/brut
						V/Hz	W				
CB 316	33 Kg	16 Kg circa 950	A / W	D - 13g A - 18g C - 33g E - 42g	R404A	220-240 V~ 50 Hz	370 W	A 3,3 W 13	mm 500x580x690	mm 550x630x860	48/56 Kg
CB 416	42 Kg	16 Kg circa 950	A / W	D - 13g A - 18g C - 33g E - 42g	R404A	220-240 V~ 50 Hz	450 W	A 4 W 15	mm 500x580x690	mm 550x630x860	52/60 Kg
CB 425	46 Kg	25 Kg circa 1470	A / W	D - 13g A - 18g C - 33g E - 42g	R404A	220-240 V~ 50 Hz	500 W	A 4 W 14	mm 500x580x800	mm 550x630x970	56/64 Kg

Finitura: acciaio inox 18/8, scotch brite - Finishing: 18/8 stainless steel, scotch brite - Carrosserie: inox 18/8, scotch brite.



Condizioni
Conditions / Conditions

		
+21°C	+15°C	18g
Watt + 43°C  (230/50)		

			Volt	
Minimum	+10 °C	+3 °C	-10 %	1bar (14psi)
Maximum	+43 °C	+32 °C	+10 %	6bar (84psi)



www.bremaice.it
info@bremaice.it